

PowerLogic™ PM8000 Series Technical Datasheet

The PowerLogic™ PM8000 series meters are compact, cost-effective multifunction power meters that will help you ensure reliability and efficiency of your power-critical facility.

Reveal and understand complex power quality conditions. Measure, understand and act on insightful data gathered from your entire power system. Designed for key metering points throughout your energy infrastructure, the PowerLogic™ PM8000 series meter has the versatility to perform nearly any job you need a meter to do, wherever you need it!

Applications

Ideal for low to high voltage applications in industrial facilities, data centers, infrastructure and other critical power environments.

PB113887



METSEPM8240

PM8000 series

The solution for

Markets that can benefit from a solution that includes PowerLogic™ PM8000 series meters:

- Industry
- Data centers
- Infrastructure
- Healthcare
- Buildings

Benefits

- Makes understanding power quality simple to help operations personnel avoid downtime and helps ensure increased productivity and equipment life.
- Makes energy and power quality immediately relevant and actionable to support your operational and sustainability goals.

Competitive advantages

- Modular, flexible patented ION technology architecture enables a simple building block approach.
- Disturbance Direction Detection, modularity and compliance with latest power quality standards.
- Color screen.
- Multiple communication options.
- Excellent accuracy.

Power management solutions

Schneider Electric provides innovative power management solutions to increase your energy efficiency and cost savings, maximize electrical network reliability and availability, and optimise electrical asset performance.

Conformity of standards

- EN 50160
- EN 50470
- IEC 61000-4-30
- IEC 61010-1
- IEC 61326-1
- IEC 61557-12
- IEC 62052-11
- IEC 62053-11
- IEC 62053-22
- IEC 62053-23
- IEC 62053-24
- IEC 62586-2
- IEEE 519
- UL 61010-1

PB113696



PowerLogic™ PM8000 DIN rail meter- underside

PB113668



PowerLogic™ PM8000 series meter - rear view

PB113692

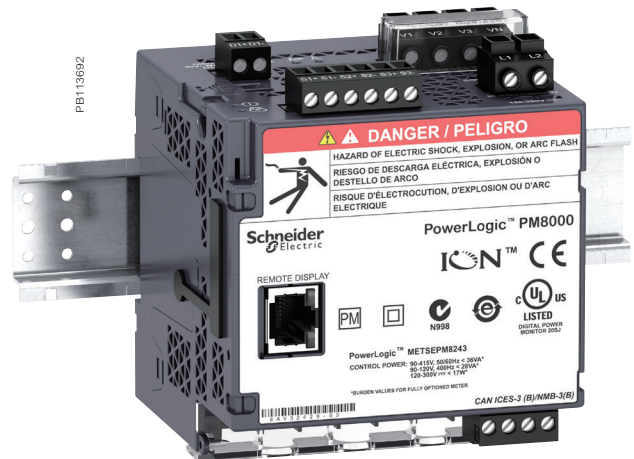

PowerLogic™ PM8000 DIN rail mounted meter

PM8000 series



PowerLogic™ PM8000 series meter

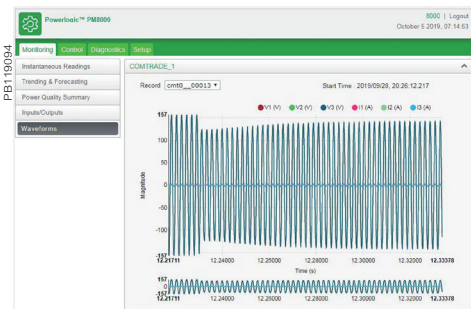

PowerLogic™ PM8000 series waveform web page sample

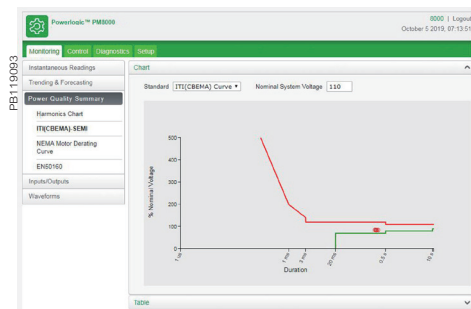

PowerLogic™ PM8000 series CBEMA web page sample

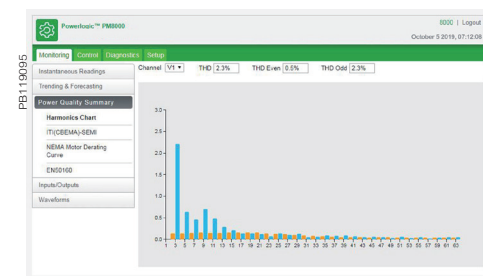

PowerLogic™ PM8000 series PQ harmonics web page sample

Main characteristics

- Precision metering:
 - IEC 61557-12 PMD/SD/K70/0.2 and PMD/SS/K70/0.2 3000m (performance measuring and monitoring functions).
 - Class 0.2S accuracy IEC 62053-22, ANSI C12.20 Class 0.2 (active energy).
 - Industry leading Class 0.5S accuracy for reactive energy (IEC 62053-24).
 - Cycle-by-cycle RMS measurements updated every ½ cycle.
 - Full 'multi-utility' WAGES metering support.
 - Net metering.
 - Anti-tamper protection seals and hardware metrology lock.
- PQ compliance reporting and basic PQ analysis:
 - Monitors and logs parameters in support of international PQ standards,
 - IEC 61000-4-30 Class A/S (test methods as per IEC 62586-2).
 - Generates onboard PQ compliance reports accessible via onboard web pages:
 - Basic event summary and pass/fail reports, for EN 50160 for power frequency, supply voltage indication, supply voltage dips, short and long interruptions, temporary over voltages, voltage unbalance and harmonic voltage.
 - ITIC (CBEMA) and SEMI curves, with alarm categorization to support further analyses.
 - NEMA Motor Derating curve.
 - Pass/fail report for IEEE 519 for voltage and current harmonic limits.
 - Harmonic analysis:
 - THD on voltage and current, per phase, min/max, custom alarming.
 - Individual harmonic magnitudes and angles on voltage and current, up to the 63rd harmonic.
 - High resolution waveform capture: triggered manually or by alarm, captured waveforms available directly from the meter via SFTP in a COMTRADE format.
 - Disturbance detection and capture: sag/swell on any current and voltage channel, alarm on disturbance event, waveform capture with pre-event information.
 - Patented Disturbance Direction Detection: provides indication of the captured disturbance occurring upstream or downstream of the meter; timestamped results provided in the event log, with degree of certainty of disturbance direction.
- Used with Schneider Electric's sophisticated software tools, provides detailed PQ reporting across entire network:
 - EN 50160 report.
 - IEC 61000-4-30 report.
 - IEEE 519 harmonic compliance report.
 - PQ compliance summary.
 - Display of waveforms and PQ data from all connected meters.
 - Onboard web-based waveform viewer.
 - Energy reports for consumption analysis and cost management.
 - WAGES dashboards and reports.
 - EcoStruxure™ Power Events Analysis, including alarm management, sequence of events, and root cause analysis.
- Cybersecurity:
 - Security events logging with Syslog protocol support.
 - HTTPS secure protocol.
 - Ability to enable or disable any communication port and any protocol per port.
 - Anti-tamper protection seals and hardware metrology lock.
 - User accounts with strong passwords.
- Data and event logging:
 - Onboard data and event logging.
 - 512 MB storage.

Feature selection

Commercial reference number	PM8000 meters
PM81XX	Essential Feature Set
PM82XX	Standard Feature Set
PM83XX	Advanced Feature Set

PM8000 series



PowerLogic™ PM8000 series meter with remote display

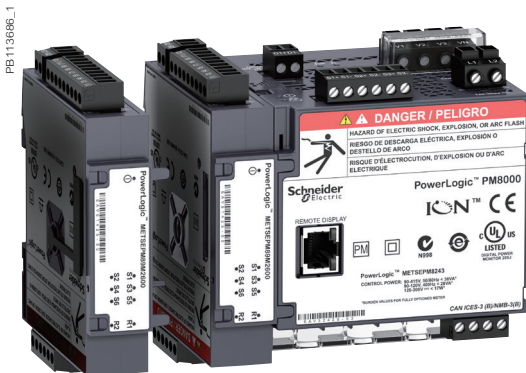

PowerLogic™ PM8000 series meter with option modules

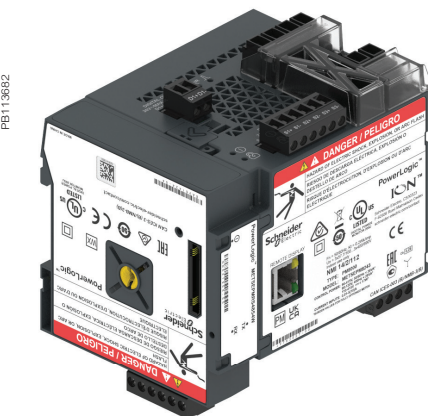

PowerLogic™ PM8000 series with RS-485 4-Wire module

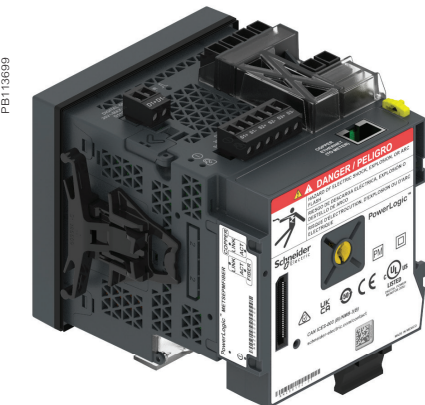

PowerLogic™ PM8000 series with Fiber-Ethernet Module

Main characteristics (contd.)

- No data gaps due to network outages or server downtime.
- Min/Max log for standard values.
- Up to 64 user definable data logs, recording up to 16 parameters on a cycle-by-cycle or other user definable interval.
- Continuous logging or 'snapshot' triggered by setpoint and stopped after defined duration.
- Trend energy, demand and other measured parameters.
- Forecasting via web pages: average, minimum and maximum for the next four hours and next four days.
- Advanced time-of-use capability.
- Security / event log: alarm conditions, metering configuration changes, power outages, firmware download, and user login/logout all timestamped to ±1 millisecond.

- Alarming and control:

- 50+ definable alarms to log critical event data, trigger waveform recording, or perform control function.
- Trigger on any condition, with 1/2-cycle and 1-second response time.
- Combine alarms using Boolean logic and to create alarm levels.
- Alarm notification via email.
- In conjunction with Schneider Electric's EcoStruxure™ software, alarms, software alarms, and alarm frequency are categorized and trended enabling sequence of events and root cause analyses.

Usability

- Easy installation and setup:

- Panel and DIN rail mounting options, remote display option.
- Pluggable connectors.
- Free setup application simplifies meter configuration.
- Auto-discovery using DPWS (Device Profile Web Services).
- DHCP for automatic IP address configuration.

- Front panel:

- Easy to read color graphic display.
- Simple, intuitive menu navigation with multi-language (8) support.

- Flexible remote communications:

- Multiple simultaneously operating communication ports and protocols allow interfacing with other automation systems; (e.g. waveforms, alarms, billing data, etc.) can be uploaded for viewing/analysis while other systems access real-time information.
- Supports Modbus, ION, DNP3, IEC 61850.
- Dual port Ethernet: 10/100BASE-TX; supports IPV4 and IPV6; daisy-chaining capability removes need for additional switches.
- Fiber-Ethernet option module: Multi-mode 100Base-FX with SC duplex connector
- Secure web interface with HTTPS and TLS 1.2 with support for user-provided certificates.
- Create redundant network loop using Rapid Spanning Tree Protocol (RSTP) and managed Ethernet switches.
- Customize TCP/IP port numbers and enable/disable individual ports.
- RS-485 2-wire connection, up to 115,200 baud, Modbus RTU, ION and DNP3 protocols.
- 4-Wire RS-485 option module: Up to 115,200 baud, Modbus RTU, ION and DNP3 protocols.
- Ethernet to serial gateway with Modbus Master functionality, connecting to 31 downstream serial Modbus devices. Also supports Modbus Mastering over TCP/IP (Ethernet) network.
- Full function web server with factory and customizable pages to access real-time and PQ compliance data.

PM8000 series



PowerLogic™ I/O module

- Time synchronization via:
 - GPS clock (RS-485) or IRIG-B (digital input) to ±1 millisecond.
 - Network Time Protocol (NTP/SNTP).
 - Precision Time Protocol (PTP - IEEE 1588 / IEC 61588).
 - Time set function from Schneider Electric software server.

Adaptability

- ION™ frameworks are customizable, scalable applications with object-oriented programming that compartmentalizes functions, and increases flexibility and adaptability.
- Applications include: accessing and aggregating data from downstream Modbus devices over serial or across the network (Modbus TCP/IP), logging and/or processing data through totalization, unit conversion or other calculations, applying complex logic for alarming or control operations, and visualization via webpages.

Standard meter I/O

- 3 digital status/counter inputs.
- 1 KY (form A) energy pulse output for interfacing with other systems.

Advanced Metering Option Modules

- Expanding meter's flexibility with communication and I/O option modules
- Powered from meter base

I/O Expansion Option Modules

Option modules include:

- Digital module:
 - 6 digital status/counter inputs.
 - 2 Form C relay outputs, 250 V, 8 A.
- Analog module:
 - 4 analog inputs (4-20 mA; 0-20 mA; 0-30 V).
 - 2 analog outputs (4-20 mA; 0-20 mA; 0-10 V) for interfacing with building management sensors and systems.

Communication Option Modules

Option modules include:

- 4-Wire RS-485 Module ⁽⁺¹⁾:
 - Adds 4-wire support to the meter i.e. eliminating the cost and efforts of rewiring while replacing/retrofitting legacy 4-Wire RS-485 systems
 - Pluggable screw terminal connector
- Fiber-Ethernet Module ⁽⁺²⁾:
 - Provides isolated data transmission through fiber optics up to 2000 m length
 - Supports multi-mode 100Base-FX type
 - SC duplex connector

⁽⁺¹⁾ Onboard 2-Wire RS-485 port is disabled with the optional module.

⁽⁺²⁾ Connected to the meter base using Ethernet patch cable (included with the module)

Maximum of 4 optional modules in total (Fiber-Ethernet, 4-Wires RS-485, I/O modules) can be connected to the meter. Only 1 Fiber-Ethernet and 1 4-Wire RS-485 option module is supported per meter.

Please refer to the option module **Installation Guides** for more details.

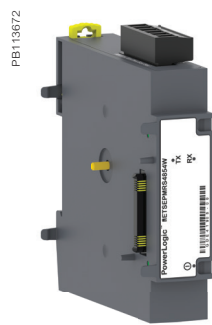

4-Wire RS-485 Option Module

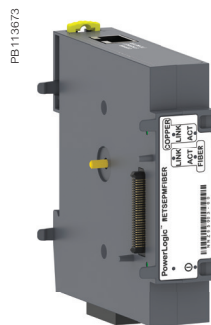

Fiber-Ethernet Option Module

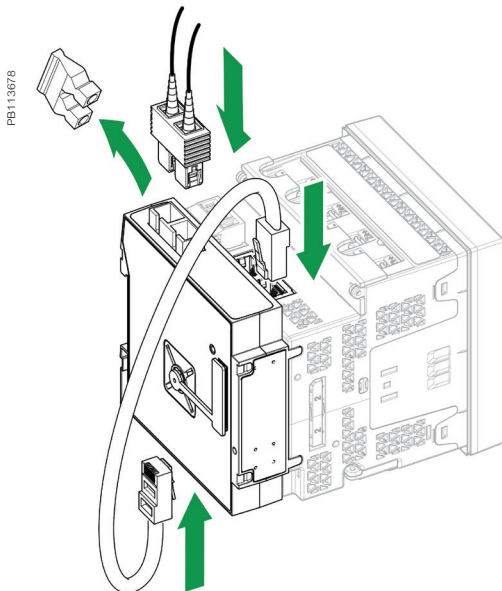

PowerLogic™ PM8000 connection with Fiber-Ethernet module

PM8000 series

Feature guide

		PM8000 Essential	PM8000 Standard	PM8000 Advanced
General				
Use on LV, MV, and HV systems		■	■	■
Current accuracy		0.1 % reading	0.1 % reading	0.1 % reading
Voltage accuracy		0.1 % reading	0.1 % reading	0.1 % reading
Active energy accuracy		0.2 Class	0.2 Class	0.2 Class
Number of samples/cycle or sample frequency		256 ⁽⁺³⁾	256	512
ION programability		■	■	■
Instantaneous rms values				
Current, voltage, frequency		■	■	■
Active, reactive, apparent power	Total and per phase	■	■	■
Power factor	Total and per phase	■	■	■
Current measurement range (autoranging)		0.05 - 10 A	0.05 - 10 A	0.05 - 10 A
Energy values				
Active, reactive, apparent energy		■	■	■
Settable accumulation modes		■	■	■
Demand values				
Current	Present and max.values	■	■	■
Active, reactive, apparent power	Present and max.values	■	■	■
Predicted active, reactive, apparent power		■	■	■
Synchronization of the measurement window		■	■	■
Setting of calculation mode	Block, sliding	■	■	■
Power quality measurements				
Harmonic distortion	Current and voltage	■	■	■
Individual harmonics	Via front panel and web page	31	63	63
	Via EcoStruxure™ software	-	127	127
Waveform capture		■ ⁽⁺³⁾	■	■
Detection of voltage swells and sags		■	■	■
Fast acquisition	1/2 cycle data	■	■	■
IEC 61000-4-30 Class A/S		-	S	A
EN 50160 Interharmonic		-	-	■
IEC 61000-4-15		-	-	■
EN 50160 compliance checking		-	■	■
IEEE 519 compliance checking		-	■	■
Disturbance Direction Detection		-	■	■
Rapid Voltage Change		-	■	■
Customizable data outputs (using logic and math functions)		■	■	■
Data recording				
Min/max of instantaneous values		■	■	■
Event logs		■	■	■
Trending/forecasting		-	■	■
SER (Sequence of event recording)		■	■	■
Time stamping		■	■	■
GPS synchronization (±1 ms)		■	■	■
Data Recorder		10	50	64
Memory Channels		160	800	1024
Storage (in Mbytes)		64	512	512

⁽⁺³⁾ Waveform capture is limited to 128 Samples/cycle recording.

PM8000 series

Feature guide (Contd.)

	PM8000 Essential	PM8000 Standard	PM8000 Advanced
Display and I/O			
Front panel display	■	■	■
Wiring self-test	■	■	■
Pulse output	1	1	1
Digital or analog inputs (max)	27 digital 16 analog	27 digital 16 analog	27 digital 16 analog
Digital or analog outputs (max, including pulse output)	1 digital 8 relay 8 analog	1 digital 8 relay 8 analog	1 digital 8 relay 8 analog
Communication			
2-Wire RS-485 port	1	1	1
Ethernet port	2	2	2
Serial port (Modbus, ION, DNP3)	■	■	■
Ethernet port (Modbus/TCP, ION TCP, DNP3 TCP, DHCP, DNS, IPv4, IPv6, IEC 61850)	■	■	■
Ethernet gateway	■	■	■
Alarm notification via email	■	■	■
HTTP/HTTPs web server with waveform viewer	■	■	■
SNMP with custom MIB and traps for alarms	■	■	■
SMTP email	■	■	■
PTP and NTP time synchronization	■	■	■
FTP file transfer	■	■	■
Option module with 4-Wire RS-485 port	■	■	■
Option module with Fiber-Ethernet port	■	■	■

Commercial references

Essential	Standard	Advanced	Description
METSEPM8140	METSEPM8240	METSEPM8340	96 x 96 panel mount meter, AC/DC power
METSEPM8110	METSEPM8210	METSEPM8310	96 x 96 panel mount meter, LV DC power
METSEPM8143	METSEPM8243	METSEPM8343	DIN rail mount meter, AC/DC power
METSEPM8113	METSEPM8213	METSEPM8313	DIN rail mount meter, LV DC power
METSEPM8144	METSEPM8244	METSEPM8344	DIN rail mount meter with remote display, AC/DC power
METSEPM8114	METSEPM8214	METSEPM8314	DIN rail mount meter with remote display, LV DC power
METSEPM81401	METSEPM82401	METSEPM83401	MID approved panel mount meter ⁽⁺⁴⁾
-	METSEPM82403	-	RMICAN approved panel mount meter ⁽⁺⁵⁾
METSEPM81404	METSEPM82404	METSEPM83404	RMICAN sealed panel mount meter ⁽⁺⁵⁾
Accessories	Description		
METSEPM89RD96	Remote display, 3 metre cable, mounting hardware for 30 mm hole (nut & centering pin), mounting hardware for DIN96 cutout (92 x 92 mm) adapter plate		
METSEPM89M2600	Digital I/O module (6 digital inputs & 2 relay outputs)		
METSEPM89M0024	Analog I/O module (4 analog inputs & 2 analog outputs)		
METSECAB10	Display Cable, 10 m		
METSEPM8HWK	Replacement hardware kit (connectors, screws, retainer clips, mounting template)		
METSEPMRS4854W	4-Wire RS 485 option module		
METSEPMFIBER	Fiber-Ethernet option module		
METSEPM8000SK	Sealing kit		

⁽⁺⁴⁾ For UK + EU only.

⁽⁺⁵⁾ For Canada only.

PM8000 series

Technical Specifications

Electrical characteristics		
Type of measurement		True rms to 512 samples per cycle
Measurement accuracy	Current & voltage	Class 0.2 as per IEC 61557-12
	Active Power	Class 0.2 as per IEC 61557-12
	Power factor	Class 0.5 as per IEC 61557-12
	Frequency	Class 0.02 as per IEC 61557-12
	Active energy	Class 0.2S IEC 62053-22 Class 0.2 IEC 61557-12, ANSI C12.20 Class 0.2
	Reactive Energy	Class 0.5S IEC 62053-24*
MID Directive		EN 50470-1, EN 50470-1, AnnexB & AnnexD (optional model)
Display refresh rate		1/2 cycle or 1 second
Input-voltage characteristics	Specified accuracy voltage	57 - 400 V L-N / 100 - 690 V L-L
	Impedance	5 MΩ per phase
	Specified accuracy frequency - Frequency	42 to 69 Hz (50/60 Hz nominal)
	Limit range of operation - frequency	20 to 450 Hz
Input-current characteristics	Rated nominal current	1 A (0.2S), 5 A (0.2S) , 10 A (0.2 ANSI)
	Specified accuracy current range	Starting Current: 5 mA Accurate Range: 50 mA - 10 A
	Permissible overload	200 A rms for 0.5 s, non-recurring
	Impedance	0.0003 Ω per phase
	Burden	0.01 VA max at 5 A
Power supply AC/DC	AC	90-415 V AC ±10 % (50/60 Hz ±10 %) 90-120 V AC +/- 10% (400 Hz)
	DC	110-415 V DC ±15 % (20-60 V DC ±10 % for PM8210)
	Ride-through time	100 ms (6 cycles at 60 Hz) min., any condition 200 ms (12 cycles at 60 Hz) typ., 120 V AC 500 ms (30 cycles at 60 Hz) typ., 415 V AC
	Burden	Typical: 7.7 W / 16 VA at 230 V (50/60 Hz) Fully optioned: max. 18 W / 40 VA at 415 V (50/60 Hz)
Power supply LV DC	DC	20 to 60 V DC ±10 %
	Burden	Fully optioned: max. 18 W at 18 to 60 V DC
Input/outputs	Meter Base Only	3 digital inputs (30 V AC/60 V DC) 1 form A (KY) solid state digital output (30 V AC/60 V DC, 75 mA)
	Optional	Digital - 6 digital inputs (30 V AC / 60 V DC) wetted + 2 form C relay outputs (250 V AC, 8 A) Analog - 4 analog inputs (4-20 mA, 0-30 V DC) + 2 analog outputs (4-20 mA, 0-10 V DC)
Mechanical characteristics		
Weight		Integrated Display Model 0.581 kg DIN rail mounted Model 0.528 kg IO modules 0.140 kg Remote display 0.300 kg
IP degree of protection		IP 54, UL type 12: Panel mount and Remote display, front IP 30: Panel mount rear, DIN rail mount, I/O modules
Excellent quality		ISO 9001 and ISO 14000 certified manufacturing
Dimensions	Panel mount model	96 x 96 x 77.5 mm
	DIN model	90.5 x 90.5 x 90.8 mm
	Remote display	96 x 96 x 27 mm
	IO modules	90.5 x 90.5 x 22 mm
Environmental conditions		
Operating temperature		-25 °C to 70 °C
Remote Display Unit		-25 °C to 60 °C
Storage temperature		-40 °C to 85 °C
Humidity rating		5 % to 95 % non-condensing
Installation category		III
Operating altitude (maximum)		3000 m above sea-level
Electromagnetic compatibility		
EMC standards		IEC 62052-11 and IEC 61326-1
Immunity to electrostatic discharge		IEC 61000-4-2
Immunity to radiated fields		IEC 61000-4-3
Immunity to fast transients		IEC 61000-4-4
Immunity to surges		IEC 61000-4-5
Immunity to conducted disturbances		IEC 61000-4-6
Immunity to power frequency magnetic fields		IEC 61000-4-8
Immunity to conducted disturbances, 2-150kHz		CLC/TR 50579
Immunity to voltage dips & interruptions		IEC 61000-4-11
Immunity to ring waves		IEC 61000-4-12
Conducted and radiated emissions		EN 55022, EN 55011, FCC part 15 Class B, EN55011, EN55022 Class B, ICES-003 Class B
Surge withstand Capability (SWC)		IEEE / ANSI C37.90.1

PM8000 series

Technical Specifications(Contd.)

Safety	
Safety Construction	IEC/EN 61010-1 ed.3, CAT III, 400 V L-N / 690 V L-L UL 61010-1 ed.3 and CSA-C22.2 No. 61010-1 ed.3, CAT III, 347 V L-N / 600 V L-L IEC/EN 62052-11, protective class II
Communication	
Ethernet to serial line gateway	Communicates directly with up to 31 unit load devices
Web server	Customisable pages, new page creation capabilities, HTML/XML compatible
Serial port RS-485	Baud rates of 2400 to 115200, pluggable screw terminal connector
Ethernet port(s)	2x 10/100BASE-TX, RJ45 connector (UTP)
Protocol	Modbus, ION, DNP3, IEC 61850, HTTPS, FTP, SNMP, SMTP, DPWS, RSTP, NTR, PTR, NTP/SNTP, GPS, IPv4 /IPv6, DHCP, Syslog protocols
Communication Option Modules	
Optional 4-Wire RS-485 serial port	Baud rates of 2400 to 115200, pluggable screw terminal connector
Optional Fiber-Ethernet port	Ethernet patch cable from base meter, multi-mode 100Base-FX, SC duplex connector
Firmware characteristics	
High-speed data recording	Down to 1/2 cycle interval burst recording, stores detailed characteristics of disturbances or outages. Trigger recording by a user-defined setpoint, or from external equipment
Harmonic distortion	Up to 63rd harmonic (127 th via Schneider Electric software) for all voltage and current inputs
Sag/swell detection	Analyse severity/potential impact of sags and swells: magnitude and duration data suitable for plotting on voltage tolerance curves per phase triggers for waveform recording, control
Disturbance direction detection	Determine the location of a disturbance more quickly and accurately by determining the direction of the disturbance relative to the meter. Analysis results are captured in the event log, along with a timestamp and confidence level indicating level of certainty
Instantaneous	High accuracy of standard speed (1s) and high-speed (1/2 cycle) measurements, including true rms per phase and total for: voltage, current, active power (kW), reactive power (kvar), apparent power (kVA), power factor, frequency, voltage and current unbalance, phase reversal
Load profiling	Channel assignments (Up to 1024 Channels via 64 data recorders) configurable for any measurable parameter, including historical trend recording of energy, demand, voltage, current, power quality, or any measured parameter. Trigger recorders based on time interval, calendar schedule, alarm/event condition, or manually
Trend curves	Historical trends and future forecasts to better manage demand, circuit loading, and other parameters. Provides average, min, max and standard deviation every hour for last 24 hours, every day for last month, every week for last 8 weeks and every month for last 12 months
Waveform captures	Simultaneous capture of all voltage and current channels, sub-cycle disturbance capture, ability to record from 320 cycles at 512 sample per cycle to over 2880 cycles at 16 points per cycle with user selectable sampling speed as well as pre- and post-trigger length
Alarms	Threshold alarms: adjustable pickup and dropout setpoints and time delays, numerous activation levels possible for a given type of alarm, user-defined or automatic alarm threshold settings, user-defined priority levels (optional automatic alarm setting)
Advanced Time of Use (TOU)	6 seasons; 3 different day types: weekend, weekday, and holiday; up to 8 tariffs per day type
Advanced security	Up to 50 users with unique access rights. Perform resets, time sync, or meter configurations based on user privileges
Storage	512 MB
Firmware update	Update via the communication ports
Display characteristics	
Integrated or Remote display	320 x 240 (1/4 VGA) Color LCD, configurable screens, 5 buttons and 2 LED indicators (alarm and meter status)
Languages	English, French, Spanish, Russian, Portugese, German, Italian, Chinese
Notations	IEC, IEEE
The HMI menu includes	
Alarms	Active alarms, historic alarms (50+ alarms)
Basic Reading	Voltage, current, frequency, power summary
Power	Power summary, demand, power factor
Energy	Energy total, delivered, received
Events	Timestamped verbose event log
Power Quality	EN 50160, IEEE 519, harmonics, phasor diagrams
Inputs/Outputs	Digital inputs, digital outputs, analog inputs, analog outputs
Nameplate	Model, serial and FW version
Custom Screens	Build your own metrics
Setup Menu	Meter setup, communications setup, display setup, date/time/clock setup, alarm setup, language setup, time of use setup, resets, password setup

PM8000 series

PM8000 panel mount meter dimensions

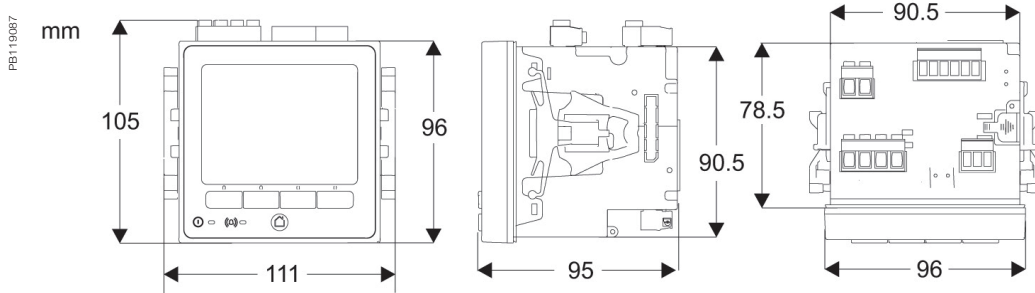

PM8000 DIN rail mount meter dimensions

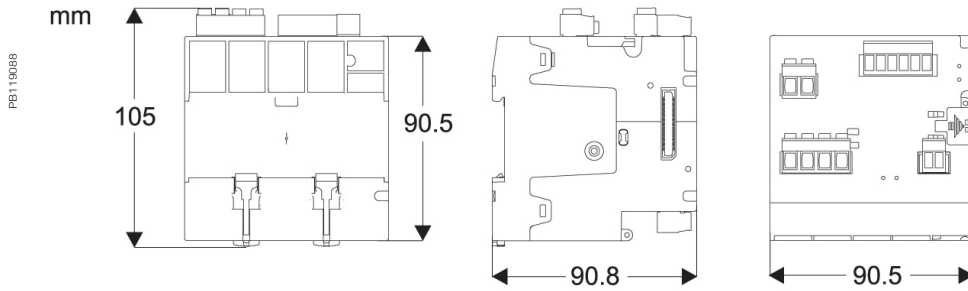

PM8000 remote display dimensions

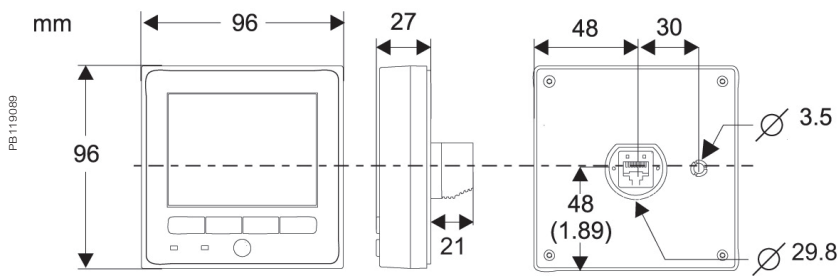

PM8000 with communication option modules

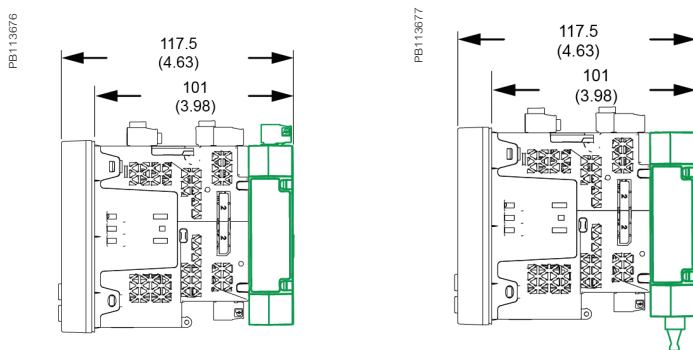

PM8000 with I/O modules dimensions

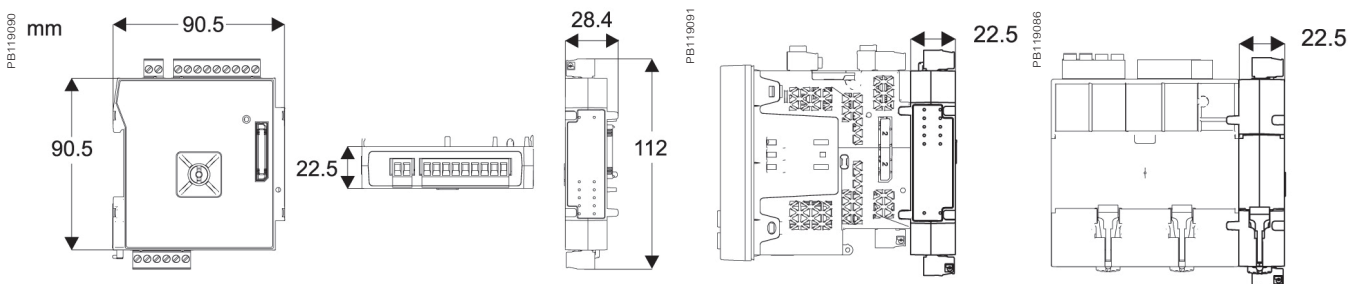

Please see the appropriate **Installation Guide** for accurate and complete information on the installation of this product.

PM8000 series

PM8000 series parts

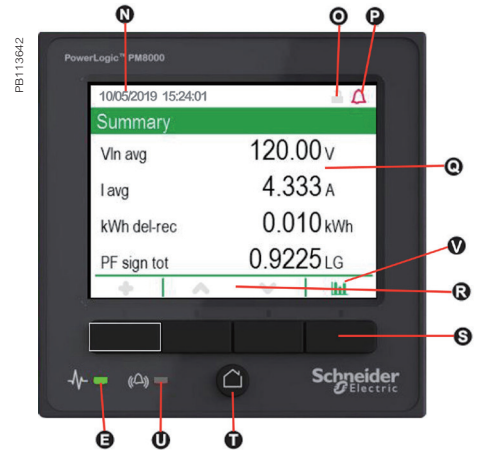
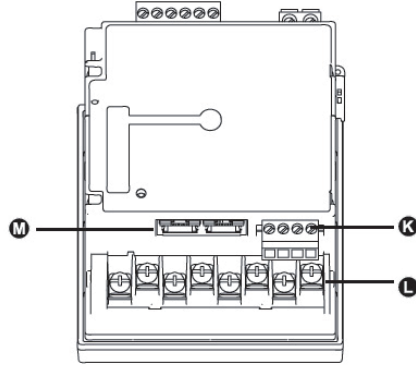
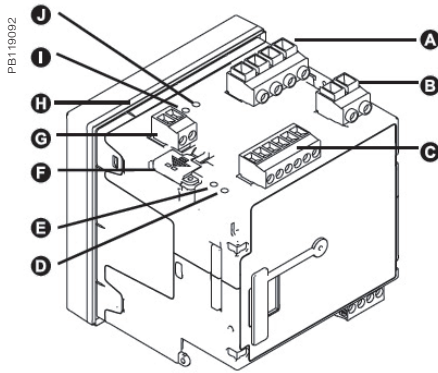

- A** Voltage inputs
- B** Control power
- C** Digital inputs
- D** Revenue lock LED (green)
- E** Status LED (green/red)
- F** Revenue lock switch
- G** Digital output
- H** Sealing gasket
- I** Infrared energy pulsing LED
- J** Energy pulsing LED

- P** Alarm icon
- Q** Display
- R** Navigation icons
 - ▲ Up
 - ▼ Down
 - ✓ Select
 - ✕ Cancel
 - ⚙ Edit
 - ⊕ More
- S** Navigation buttons
- T** Home button
- U** Alarm LED (red)
- V** Bar graph



www.se.com

Schneider Electric Industries SAS
35, Rue Joseph Monier
CS 30323
92506 Rueil Malmaison Cedex

RCS Nanterre 954 503 439
Capital social 928 298 512 €
www.se.com

September 2023
PowerLogic™ PM8000 Series
PLSED310058EN

© 2023 - Schneider Electric. All rights reserved.
All trademarks are owned by Schneider Electric
Industries SAS or its affiliated companies.

As standards, specifications and designs develop from time to time, please
ask for confirmation of the information given in this document.

Over 75 % of Schneider Electric products
have been awarded the Green Premium ecolabel.

